



特点

- 全封闭陶瓷，金属螺柱型结构
- 符合JB/T8949.2-1999标准
- 承受高浪涌电流能力
- 螺栓为阴极或阳极的正向或反向结构

典型应用

- 直流电机控制，直流电源控制
- 交流开关及温度控制，同步电机励磁

V _{RRM}	型号
1600V	ZP300A凸1600V

符号	参数	测试条件	结温 T _J (°C)	参数值			单位
				最小	典型	最大	
I _{F(AV)}	正向平均电流	180° 正弦半波,50Hz 单面散热, T _C =150°C	150			300	A
I _{F(RMS)}	正向电流有效值	直流@110°C情况温度	150			471	A
V _{RRM}	反向重复峰值电压	V _{DRM} &V _{RRM} tp=10ms	150	1600			V
I _{R(RM)}	反向重复峰值电流	V _{RM} =V _{RRM}	150			15	mA
I _{FSM}	正向不重复浪涌电流	10ms 底宽, 正弦半波 V _R =0.6V _{RRM}	150			8.25	KA
I ² t	浪涌电流平方时间积					68	10 ³ A ² S
V _{TO}	门槛电压		150			0.83	V
r _T	斜率电阻		150			0.91	mΩ
V _{FM}	通态峰值电压	I _{TM} =900A, F=9.0KN	150			1.33	V
I _{rm}	反向恢复电流	I _{TM} =900A, tq=1000us Di/dt=-20A/us. V _r =50V	150			70	A
t _{rr}	反向恢复时间					4.0	us
Q _{rr}	恢复电荷					140	uC
R _{th(j-h)}	热阻抗(结至散热器)	180° 正弦波, 双面(单面)冷却				0.090	°C/W
F _M	安装力			85		120	N
T _{stq}	储存温度			-40		150	°C
W _t	质量						g
Outline	外形						

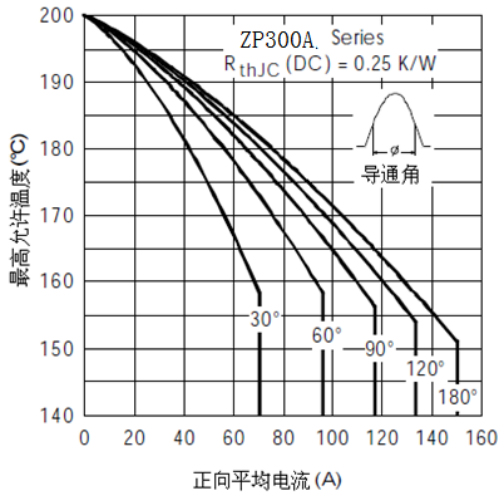

Fig. 1 - 额定电流特性

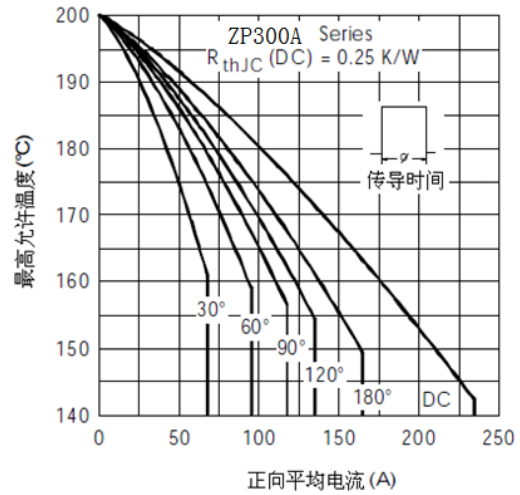

Fig. 2 - 额定电流特性

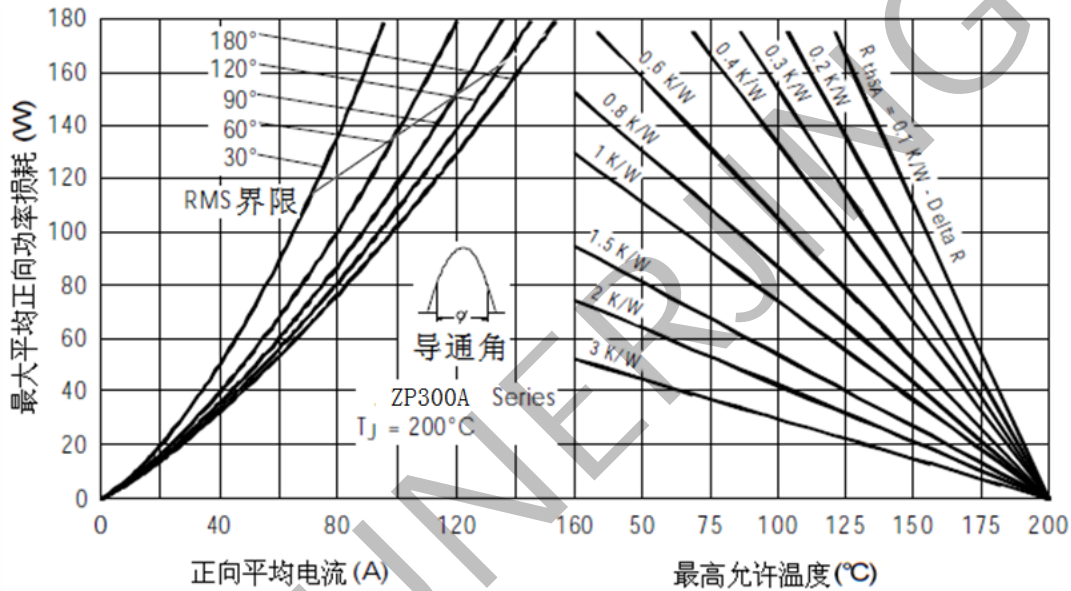

Fig. 3 - 正向功率损耗特性

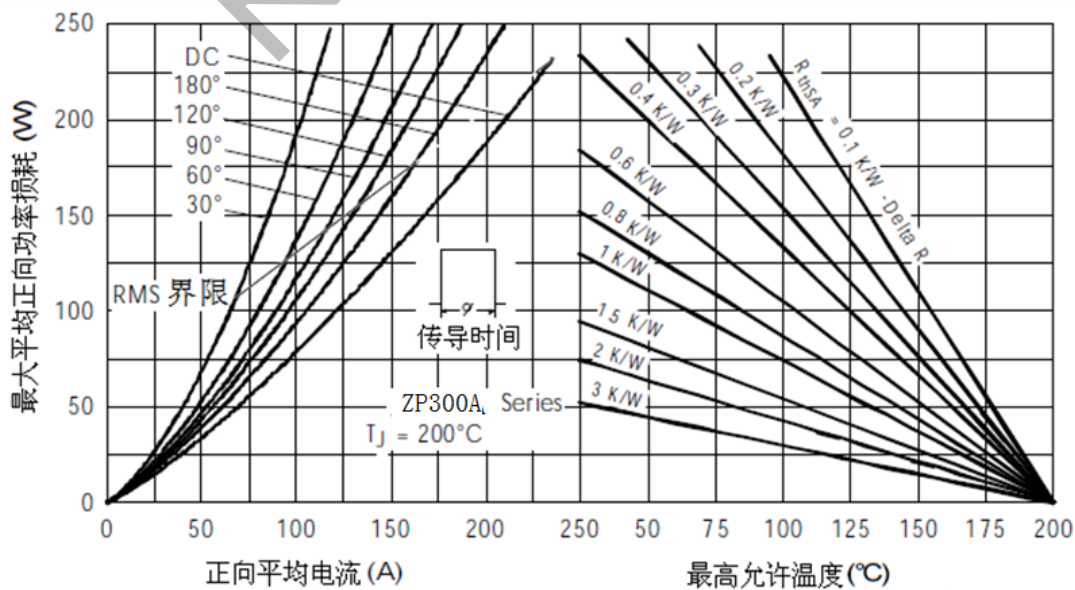

Fig. 4 - 正向功率损耗特性

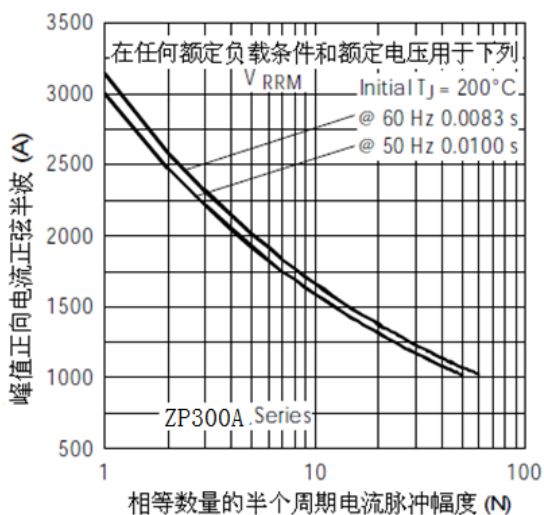

Fig. 5 - 最大反向浪涌电流

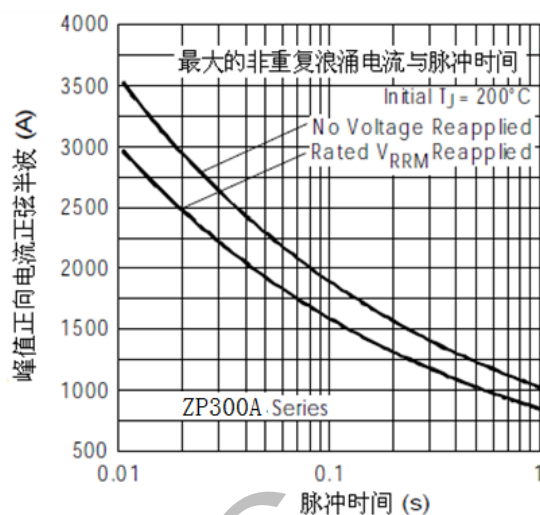

Fig. 6 - 最大反向浪涌电流

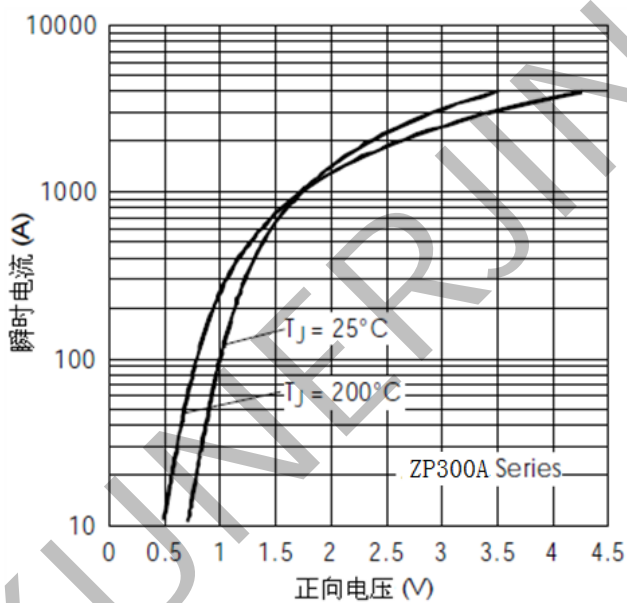

Fig. 7 - 正向压降特性

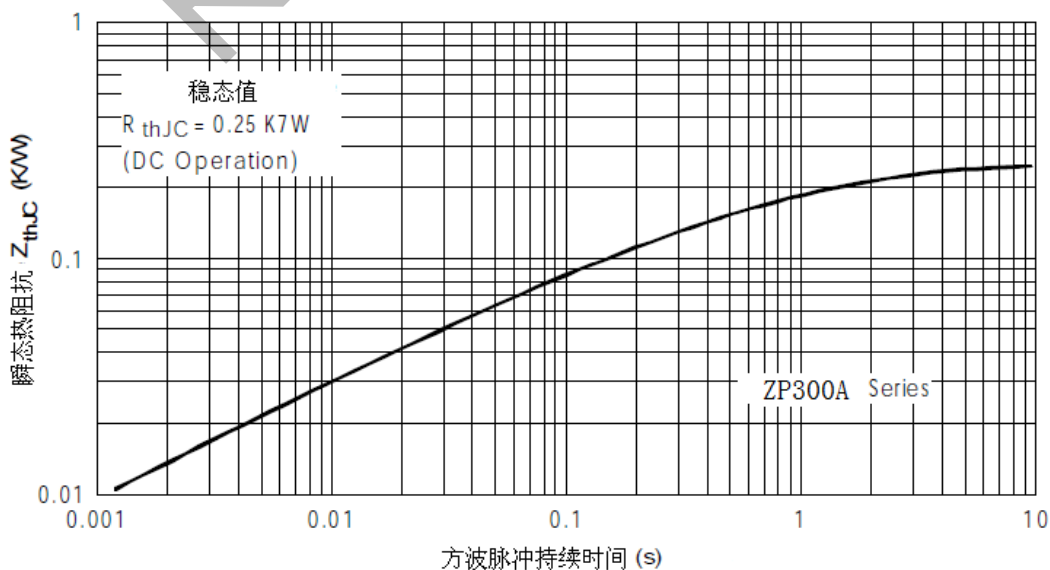
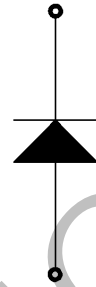
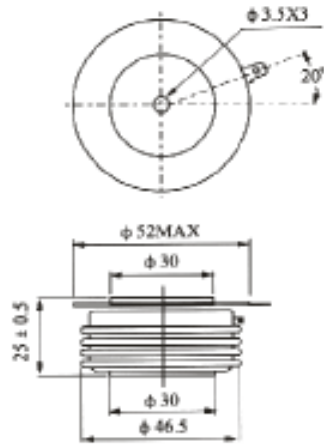

Fig. 8 - Z_{thJC} 热阻抗特性



外形图:



KUNERJING