



特点:

- 芯片与底板电气绝缘2500V交流电压

典型应用:

- 仪器设备的直流电源
- 交、直流电机控制, 电机软启动
- 各种整流电源
- 电焊机, 变频器, 电池充、放电

V_{RRM}	型号
1600V	MDC600A1600V-Y63

符号	参数	测试条件	结温 $T_J(^{\circ}C)$	参数值			单位
				最小	典型	最大	
$I_{F(AV)}$	正向平均电流	180° 正弦半波, 50Hz 单面散热, $T_C=85^{\circ}C$	150			600	A
$I_{F(RMS)}$	方均根电流		150			942	A
V_{RRM}	反向重复峰值电压	$V_{RRM} t_p=10ms$	150	1600			V
I_{RRM}	反向重复峰值电流	$V_{RM}=V_{RRM}$	150			40	mA
I_{FSM}	正向不重复浪涌电流	10ms 底宽, 正弦半波 $V_R=0.6V_{RRM}$	150			15.0	KA
I^2t	浪涌电流平方时间积					1150	10^3A^2S
V_{FO}	门槛电压		150			0.75	V
r_F	斜率电阻					0.26	$m\Omega$
V_{FM}	正向峰值电压	$I_{FM}=1800A$	25			1.35	V
$R_{th(j-c)}$	热阻抗 (结至壳)	180° 正弦波, 单面散热				0.065	$^{\circ}C/W$
$R_{th(c-h)}$	热阻抗 (壳至散)	180° 正弦波, 单面散热				0.022V	$^{\circ}C/W$
V_{iso}	绝缘电压	50Hz, R.M.S, $t=1min, I_{iso}: 1mA(max)$		2500			V
F_M	安装扭矩 (M10)			10.0		12.0	N-m
	安装扭矩 (M6)			4.5		6	N-m
T_{stq}	储存温度			-40		125	$^{\circ}C$
W_t	质量						g
Outline	外形						

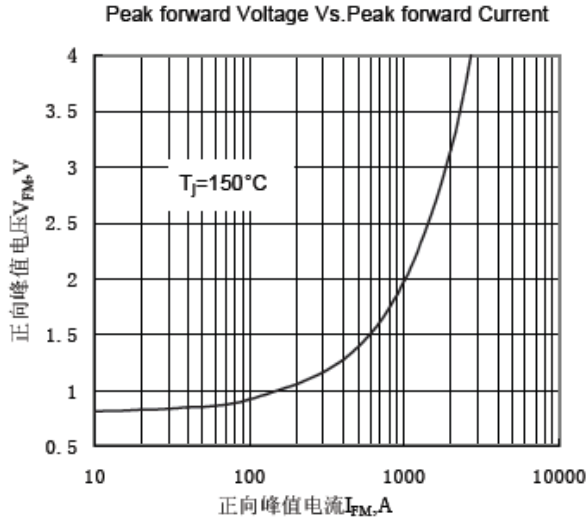

Fig.1 正向伏安特性曲线

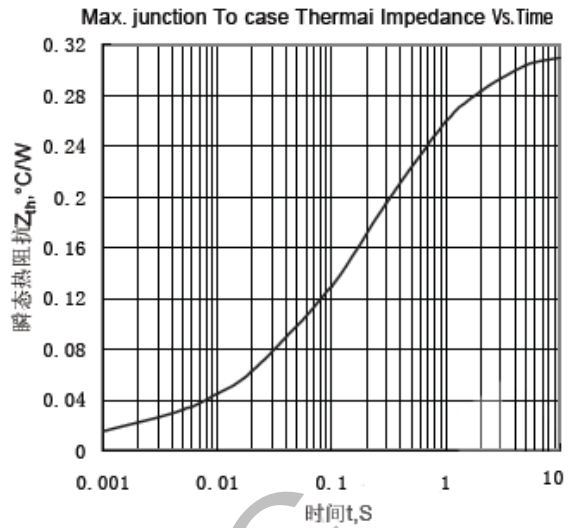

Fig.2 瞬态热阻态曲线

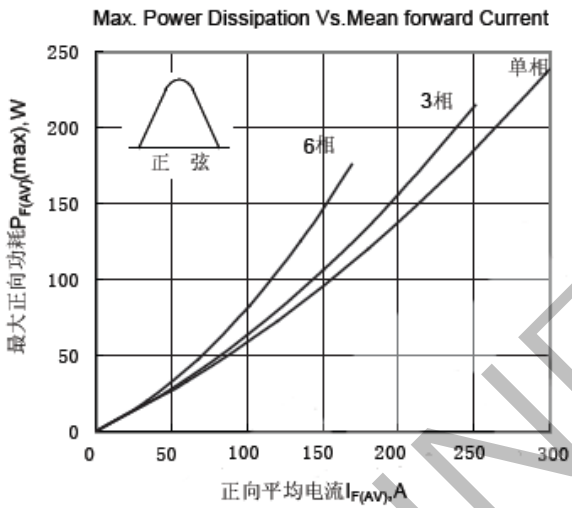

Fig.3 最大正向功耗与平均电流关系曲线

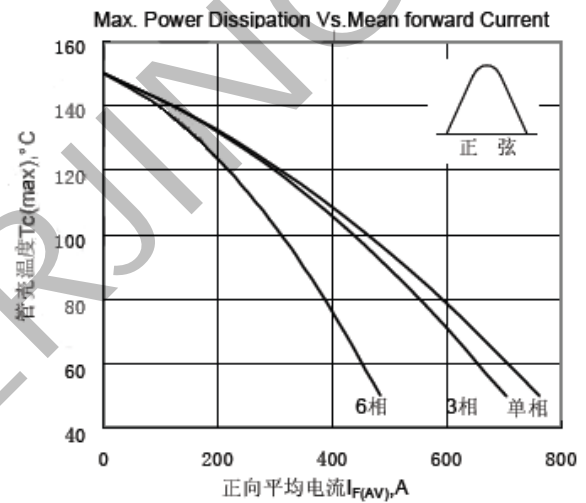

Fig.4 管壳温度与正向平均电流关系曲线

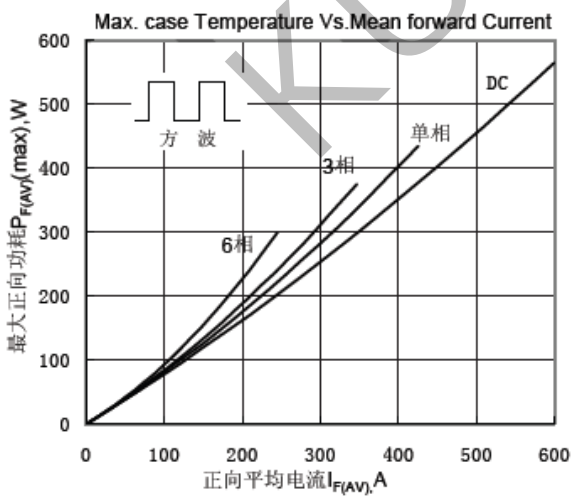

Fig.5 最大正向功耗与平均电流关系曲线

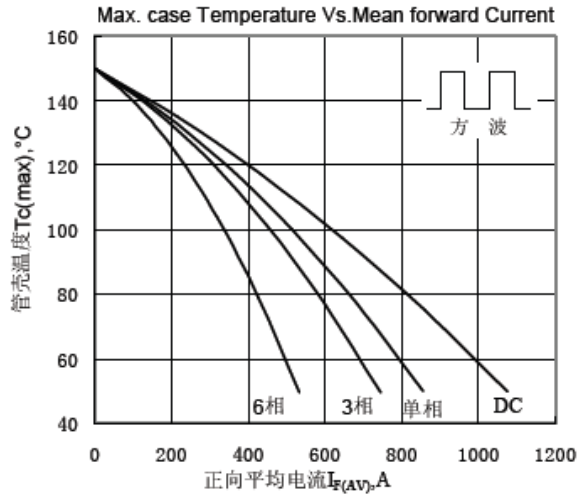

Fig.6 管壳温度与正向平均电流关系曲线

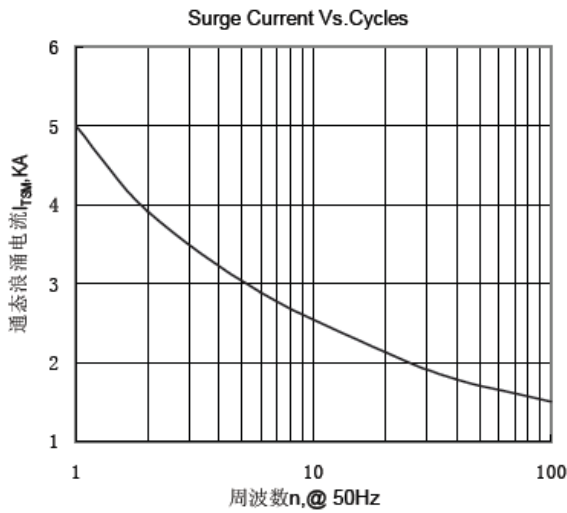

Fig.7 通态浪涌电流与周波数的关系曲线

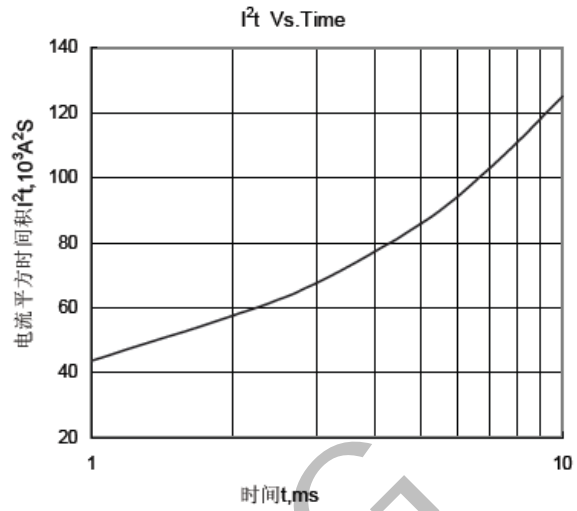
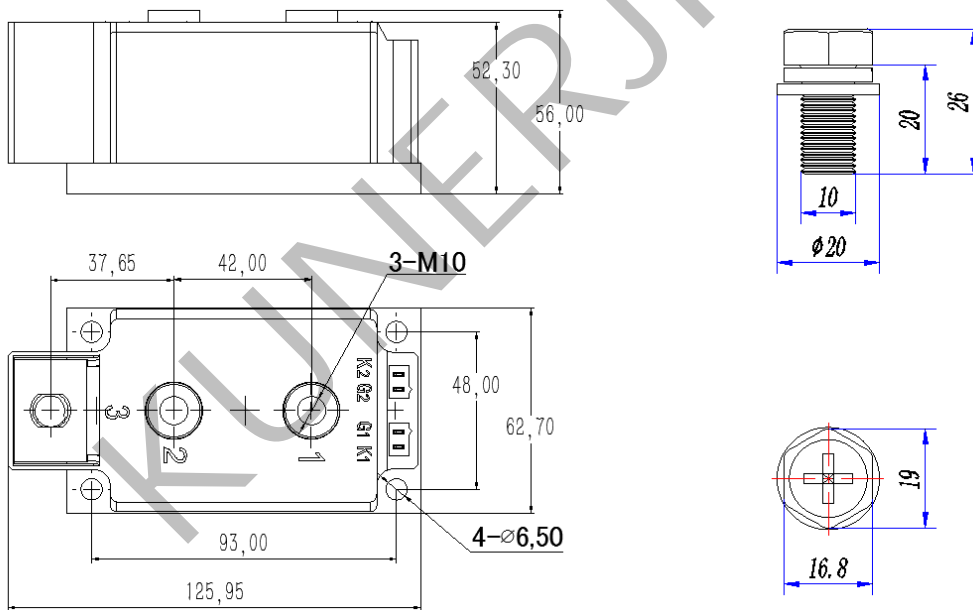

Fig.8 I²t 特性曲线

外形图:



未注尺寸公差: ±0.5mm

线路图:

