



## 特点

- 芯片与底板电气绝缘，2500V交流电压
- 优良的温度特性和功率循环能力
- 350A以下模块皆为强迫风冷，400A以上模块，风冷，水冷先用

## 典型应用

- 交直流电机控制，各种整流电源
- 工业加热控制，调光，无触点开关
- 电机软起动，无功补偿
- 电焊机，变频器，UPS电源，电池充放电

V <sub>DRM</sub> , V <sub>RRM</sub>	型号
1600V	MTC500A1600V-Y63

符号	参数	测试条件	结温 T <sub>J</sub> (°C)	参数值			单位
				最小	典型	最大	
I <sub>T(AV)</sub>	通态平均电流	180° 正弦半波, 50Hz 单面散热, T <sub>C</sub> =85°C	125			500	A
I <sub>T(RMS)</sub>	方均根电流		125			780	A
V <sub>DRM</sub> V <sub>RRM</sub>	断态重复峰值电压 反向重复峰值电压	V <sub>DRM</sub> &V <sub>RRM</sub> tp=10ms	125	1600			V
I <sub>DRM</sub> I <sub>RRM</sub>	断态重复峰值电流 反向重复峰值电流	V <sub>DM</sub> =V <sub>DRM</sub> V <sub>RM</sub> =V <sub>RRM</sub>	125			35	mA
I <sub>TSM</sub>	通态不重复浪涌电流	10ms 底宽, 正弦半波	125			14.5	KA
I <sup>2</sup> t	浪涌电流平方时间积	V <sub>R</sub> =0.6V <sub>RRM</sub>	125			1051	10 <sup>3</sup> A <sup>2</sup> S
V <sub>TO</sub>	门槛电压		125			0.80	V
r <sub>T</sub>	斜率电阻		125			0.32	mΩ
V <sub>TM</sub>	通态峰值电压	I <sub>TM</sub> =1500A	25			1.48	V
dv/dt	断态电压临界上升率	V <sub>DM</sub> =0.67V <sub>DRM</sub>	125			1000	V/us
di/dt	通态电流临界上升率	I <sub>MT</sub> =52A 门极触发电流幅值 I <sub>GR</sub> =1.5A 门极电流上升时间 t <sub>r</sub> ≤ 0.5us	125			150	A/us
I <sub>GT</sub>	门极触发电流	V <sub>A</sub> =12V, I <sub>A</sub> =1A	25	30		150	mA
V <sub>GT</sub>	门极触发电压			0.7		2.0	V
I <sub>H</sub>	维持电流			25		150	mA
V <sub>GD</sub>	门极不触发电压	V <sub>DM</sub> =0.67V <sub>DRM</sub>	125			0.2	V
R <sub>th(j-c)</sub>	热阻抗 (结至壳)	180° 正弦波, 单面散热				0.065	°C/W
R <sub>th(c-h)</sub>	热阻抗 (壳至散)	180° 正弦波, 单面散热				0.024	°C/W
V <sub>iso</sub>	绝缘电压			2500			V
F <sub>M</sub>	安装扭矩 (M10)			10.0		12.0	N-m
	安装扭矩 (M6)			4.5		6.0	N-m
T <sub>stq</sub>	储存温度			-40		125	°C
W <sub>t</sub>	质量						g
Outline	外形	Y63					

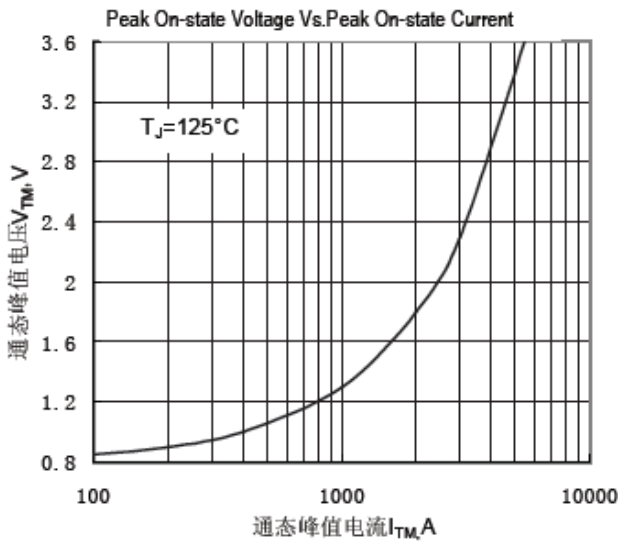

Fig.1 通态伏安特性曲线

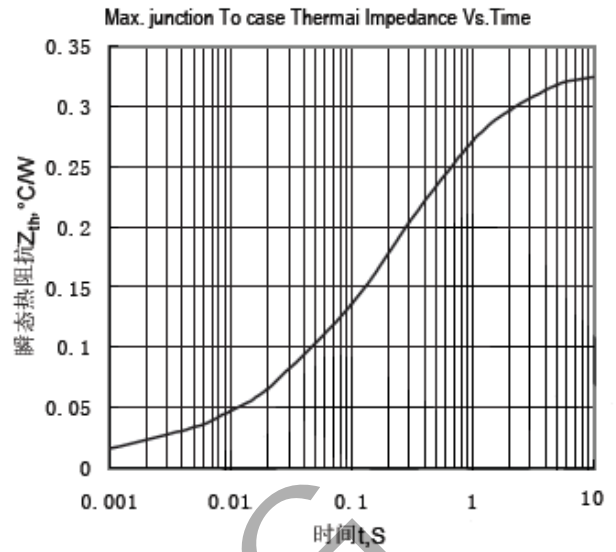

Fig.2 结至管壳瞬态热阻抗曲线

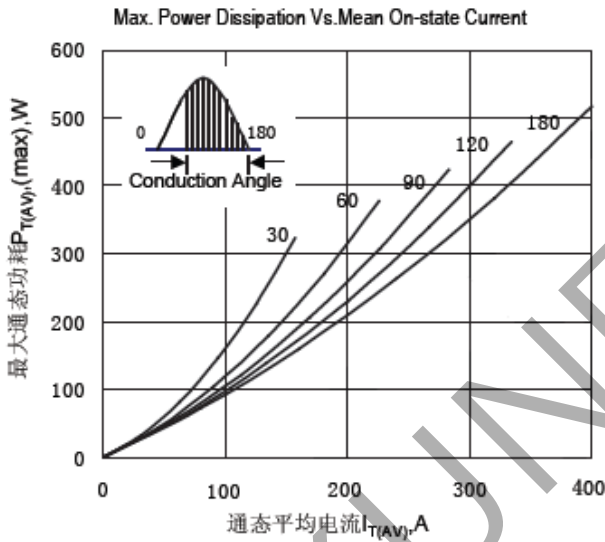

Fig.3 最大功耗与平均电流关系曲线

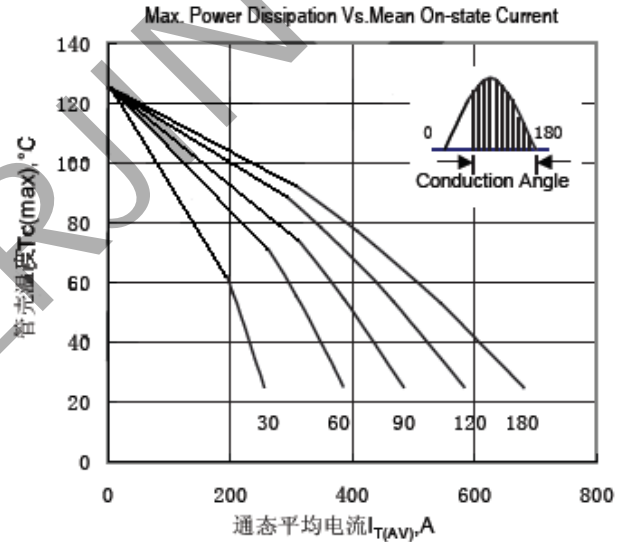

Fig.4 管壳温度与通态平均电流关系曲线

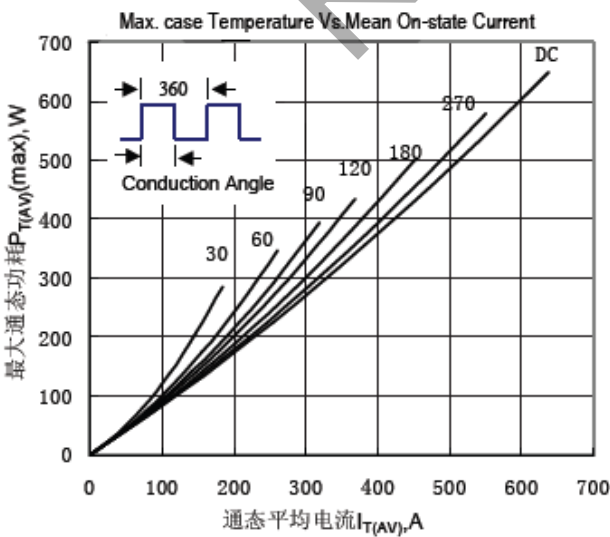

Fig.5 最大功耗与平均电流关系曲线

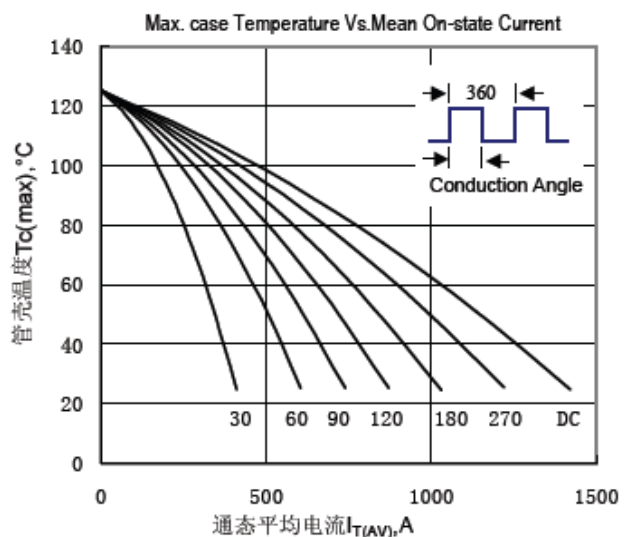

Fig.6 管壳温度与通态平均电流关系曲线

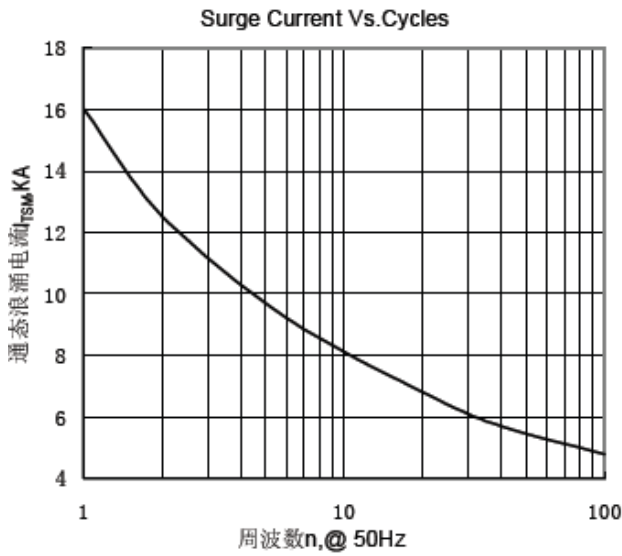

Fig.7 通态浪涌电流与周波数的关系曲线

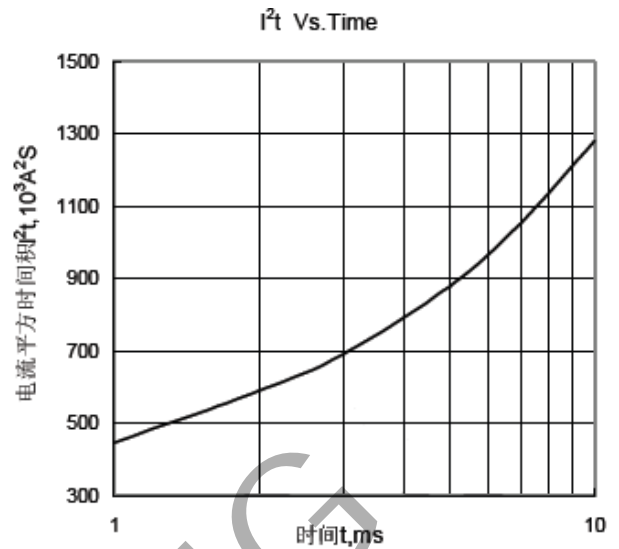

Fig.8  $I^2t$  特性曲线

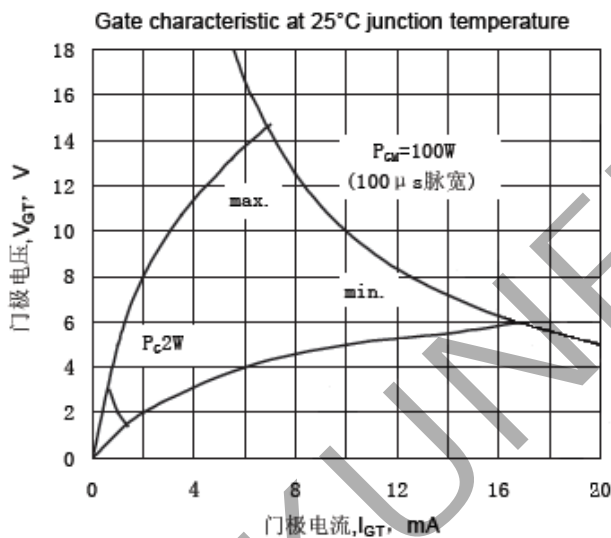

Fig.9 门极功率曲线

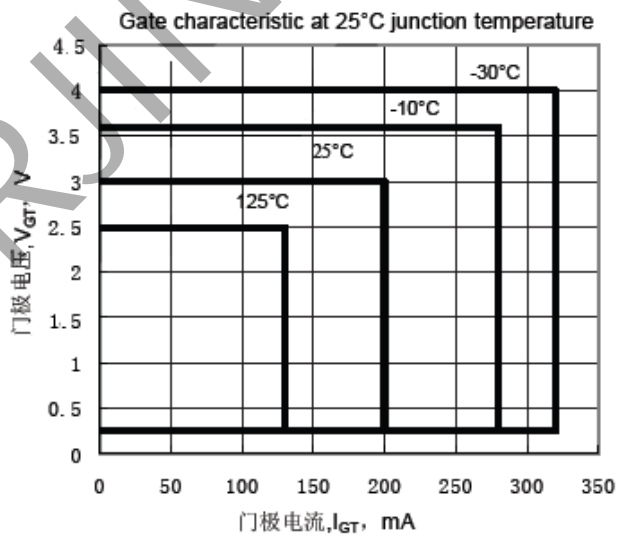
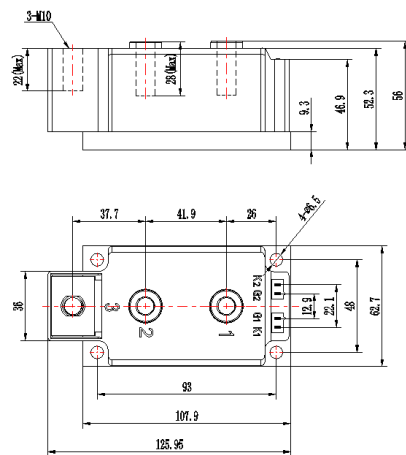
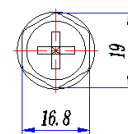
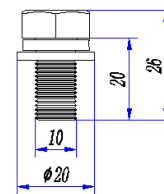

Fig.10 门极触发特性曲线

外形图:



未注尺寸公差:  $\pm 0.5mm$





线路图:

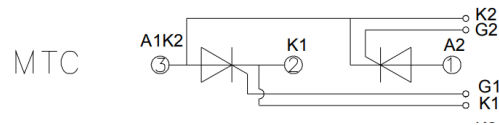

KUNERJING